

# Humidity and temperature transmitter

## TH 110



### KEY POINTS

- Measuring range from 5 to 95%RH and from 0 to 50 °C (ambient model) or from -20 to +80 °C (duct or remote model)
- 0-10 V output, active, power supply 24 Vac/Vdc (3-4 wires) or 4-20 mA output, passive loop, power supply from 16 to 30 Vdc (2 wires)
- ABS V0 housing IP65 (duct or remote model) or IP20 (ambient model), with or without display
- Alternating display of humidity and temperature
- "¼ turn" system mounting with wall-mount plate
- Housing with simplified mounting system

### FEATURES OF HOUSING

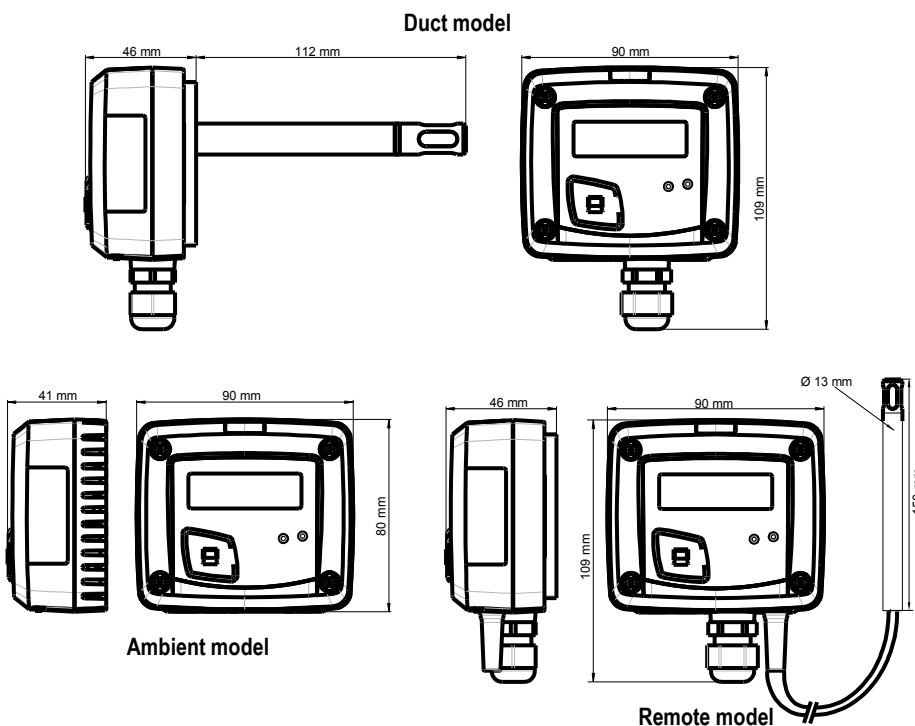

#### Material

ABS V0 as per UL94

#### Protection

IP65 (duct and remote models)  
IP20 (ambient model)

#### Display

LCD 10 digits. Size : 50 x 17 mm  
Alternating display of humidity and temperature

#### Height of digits

Values : 10 mm  
Units : 5 mm

#### Cable gland (remote and duct models)

For cables Ø 8 mm maximum

#### Weight

124 g (ambient model) ; 135 g (duct and remote models)

**Cable of remote probes** : length 2 m and Ø 4.8 mm in silicone

### PART NUMBER

To order, just add the codes to complete the part number :

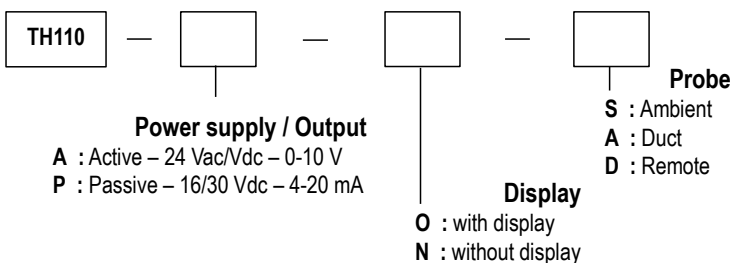

#### Example : TH110 – ANS

Humidity and temperature transmitter TH110, 0-10 V active, without display, ambient model

## TECHNICAL FEATURES IN TEMPERATURE

<b>Measuring range</b>	Ambient model : from 0 to 50 °C Remote and duct models : from -20 to +80 °C
<b>Accuracy*</b>	CMOS : $\pm 0.4$ % of reading $\pm 0.3$ °C NTC : $\pm 0.3$ °C (de -40°C à 70°C) ; $\pm 0.5$ °C outside
<b>Unit of measurement</b>	°C / °F
<b>Response time</b>	1/e (63%) 15 s
<b>Sensitive element</b>	Ambient model : CMOS Remote and duct models : NTC
<b>Resolution</b>	0.1 °C
<b>Type of fluid</b>	Air and neutral gases

\*All the accuracies indicated in this technical datasheet were stated in laboratory conditions, and can be guaranteed for measurements carried out in the same conditions, or carried out with calibration compensation.

## TECHNICAL FEATURES IN HUMIDITY

<b>Measuring range</b>	From 5 to 95% RH
<b>Accuracy**</b>	$\pm 1.5$ % RH (if $15^{\circ}\text{C} \leq T \leq 25^{\circ}\text{C}$ ) on remote and duct models $\pm 1.8$ % RH (if $15^{\circ}\text{C} \leq T \leq 25^{\circ}\text{C}$ ) on ambient model
<b>Drift linked to temperature</b>	$\pm 0.04 \times (T-20)$ %RH (if $15^{\circ}\text{C} \leq T \leq 25^{\circ}\text{C}$ )
<b>Unit of measurement</b>	% RH
<b>Response time</b>	1/e (63%) 4 s
<b>Type of sensor</b>	Ambient model : CMOS Remote and duct models : NTC
<b>Resolution</b>	0.1% RH
<b>Factory adjustment uncertainty</b>	$\pm 0.88$ % HR
<b>Type of fluid</b>	Air and neutral gases

\*\*All the accuracies indicated in this technical datasheet were stated in laboratory conditions, and can be guaranteed for measurements carried out in the same conditions, or carried out with calibration compensation.  
As per NFX 15-113 and the Charter 2000/2001 HYGROMETERS, GAL (Guaranteed Accuracy Limit) which has been calculated with a coverage factor value of 2 is  $\pm 2.58$ %RH between 18 and 28°C on the measuring range from 3 to 98%RH. Sensor drift is less than 1%RH/year.

## TECHNICAL SPECIFICATIONS

### Output / Power supply

- active sensor 0-10 V (power supply 24 Vac/Vdc  $\pm 10$ %), 3-4 wires
- passive loop sensor 4-20 mA (power supply 16/30 Vdc), 2 wires
- maximum load : 500 Ohms (4-20 mA)
- minimum load : 1 K Ohms (0-10 V)

### Consumption

2 VA (0-10 V) or max. 22 mA (4-20 mA)

### Electromagnetical compatibility

EN61326

### Electrical connection

Screw terminal block for cables  $\varnothing 0.05$  to 2.5 mm<sup>2</sup>

### PC communication

Kimo USB-mini Din cable

### Environment

Air and neutral gases

### Operating temperature of the housing

From 0 to 50 °C

### Operating temperature of the probe

From -20 to +80 °C

### Storage temperature

From -10 to +70 °C

## CONNECTIONS

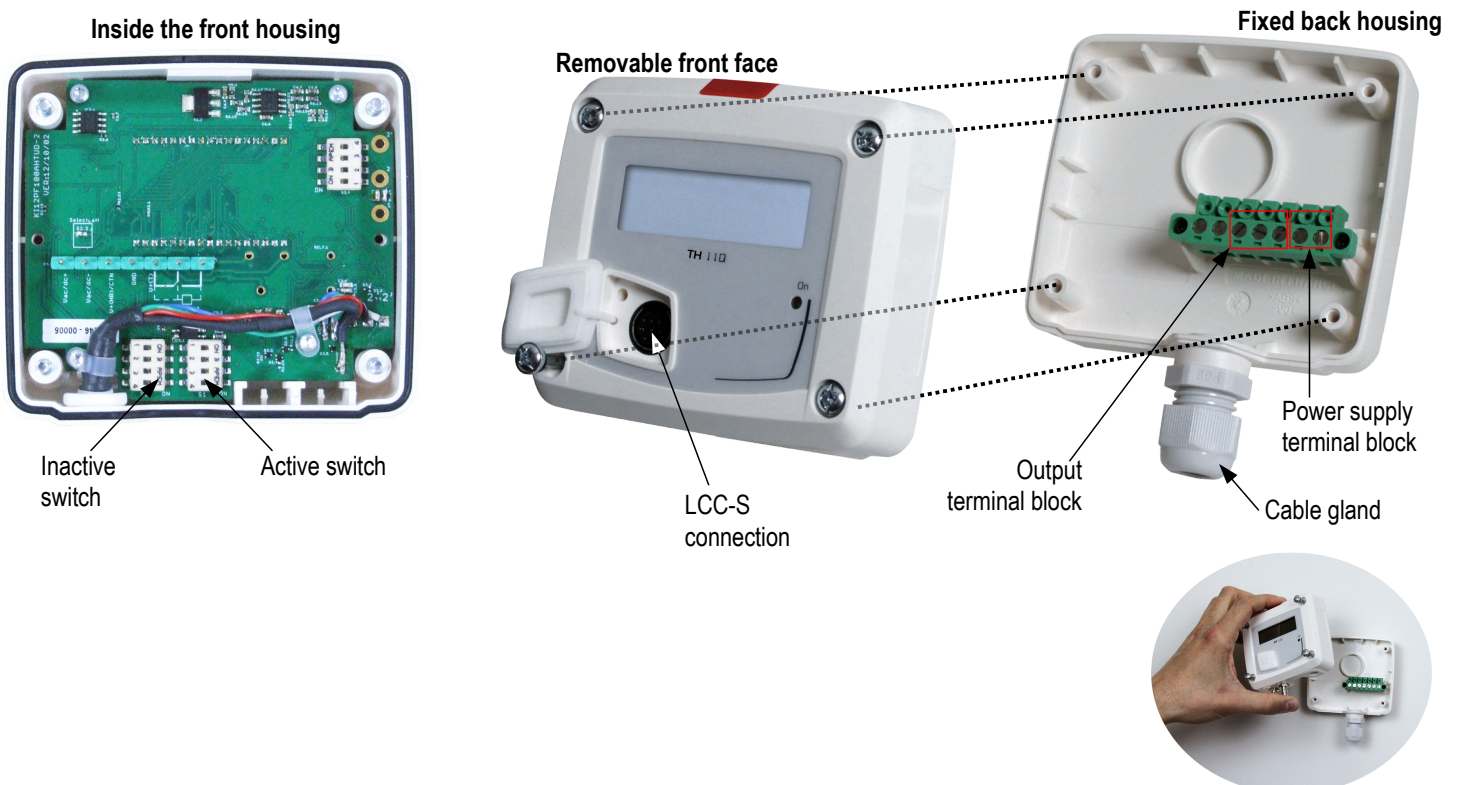

## ELECTRICAL CONNECTIONS – as per *NFC15-100 standard*

**!** This connection must be made by a qualified technician. To make the connection, the transmitter must not be energized.

For TH110-AOS, TH110-ANS, TH110-AOD, TH110-AND, TH110-AOA, TH110-ANA models with 0-10 V output – active :



To make a 3-wire connection, before powering up the transmitter, please connect the output ground to the input ground. See drawing below.

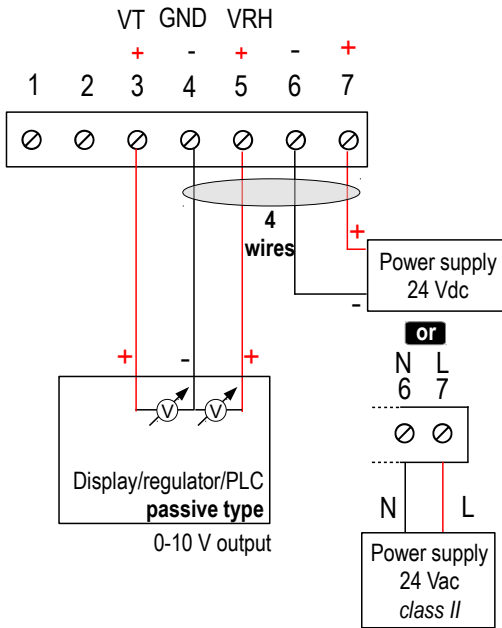

==== 4 wires

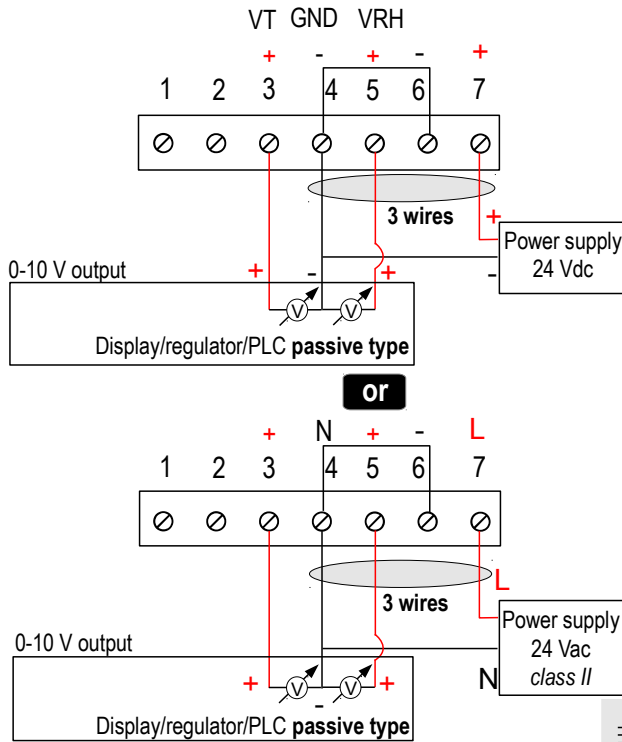

==== 3 wires

For TH110-POS, TH110-PNS, TH110-POD, TH110-PND, TH110-POA, TH110-PNA models with 4-20 mA output – passive :

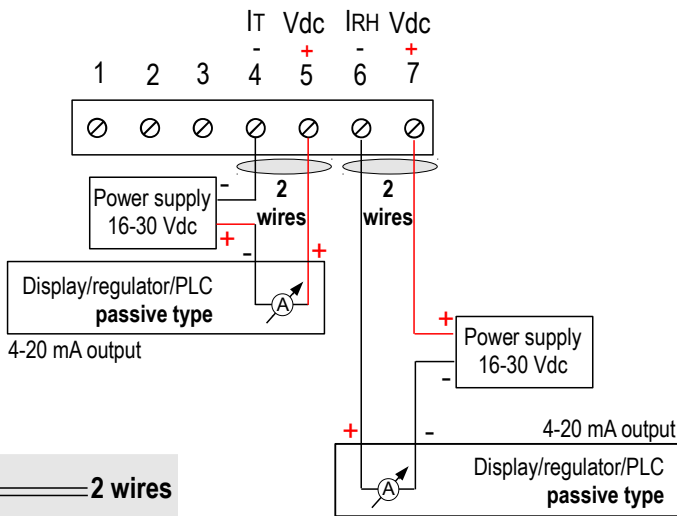

==== 2 wires

OR

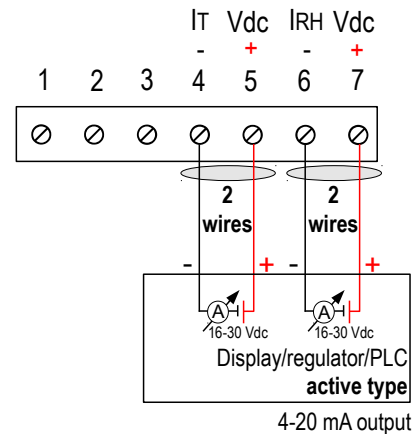

## SETTINGS AND USE OF THE TRANSMITTER

### > Configuration

It is possible to set the measuring ranges and the unit of the instrument either by switch and/or via software.



To configure the transmitter, it must not be energized. Then, you can make the settings required, with the DIP switches (as shown on the drawing below). When the transmitter is configured, you can power it up.

### > Configuration by switch



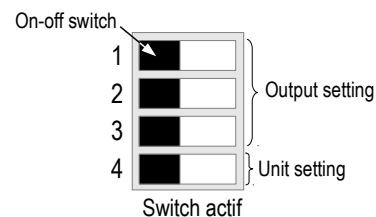





To configure the transmitter, unscrew the 4 screws from the housing then open it. DIP switches allowing the different settings are then accessible



Please follow carefully the combinations beside with the DIP switch. If the combination is wrongly done, the following message will appear on the display of the transmitter "CONF ERROR". In that case, you will have to unplug the transmitter, place the DIP switches correctly, and then power the transmitter up.

















### > Units setting – active switch

To set a unit of measurement, put the on-off switch 4 of the units as shown below.

Configurations	°C	°F
Combinations	1 	1 
	2 	2 
	3 	3 
	4 	4 

### > Outputs setting – active switch

To set an output, put the on-off switches 1, 2 et 3 of the measuring ranges as shown below.

Configurations	From 0 to +50°C	From -20 to +80°C	From -50 to +50°C	From 0 to 100°C
Combinations	1 	1 	1 	1 
	2 	2 	2 	2 
	3 	3 	3 	3 
	4 	4 	4 	4 

## CONFIGURATION VIA LCC-S SOFTWARE (option)

### An easy and friendly configuration with the software !

It is possible to configure intermediate ranges, an offset

Example : for a 0-100 °C transmitter, minimum delta minimum is 20 °C. The instrument can be configured from 0 to +20 °C or from -10 to +10 °C.

In order to compensate a possible drift of the sensor, it is possible to add an offset to the displayed value by the TH110 transmitter : it shows 48%RH, a standard instrument shows 45%RH. It is then possible, via the software, to integrate an offset of -3 to the displayed value by the TH110 instrument.

- To access the configuration via software :
  - Set the DIP switches as shown beside.
  - Connect the cable of the LCC-S to the connection of the transmitter.
- Please refer to the user manual of the LCC 100 to make the configuration.

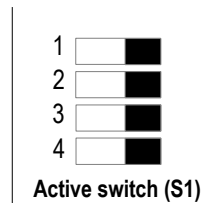

*The configuration of the parameters can be done either with the DIP switch or via software (you can not combine both solutions).*

## MOUNTING

To mount the transmitter, mount the ABS plate on the wall (drilling : Ø6 mm, screws and pins are supplied).

Insert the transmitter on the fixing plate (see A on the drawing beside). Rotate the housing in clockwise direction until you hear a "click" which confirms that the transmitter is correctly installed.



**Ambient model does not have any mounting plate.**  
**4 fixing holes are present inside the back housing. Use them to install the transmitter on the required location.**

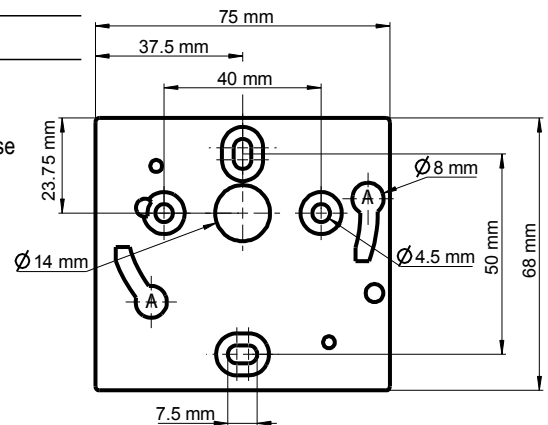

## MAINTENANCE

Please avoid any aggressive solvent. Please protect the transmitter and its probes from any cleaning product containing formalin, that may be used for cleaning rooms or ducts.

## OPTIONS AND ACCESSORIES

- **KIAL-100A** : Power supply class 2, 230 Vac input, 24 Vac output
- **LCC-S** : configuration software with USB cable
- Stainless steel sliding fittings
- PC cable gland
- ABS connection with connection gland
- Stainless steel connections
- Wall-mount plate for humidity remote probe

[www.kimo.fr](http://www.kimo.fr)

Distributed by :



**EXPORT DEPARTMENT**  
 Tel : + 33. 1. 60. 06. 69. 25 - Fax : + 33. 1. 60. 06. 69. 29  
 e-mail : export@kimo.fr